

PC818

High Density Mounting Type Photocoupler

* Lead forming type (I type) and taping reel type (P type) are also available. (PC818I/PC818P)

* TÜV (VDE0884) approved type is also available as an option.

■ Features

1. High isolation voltage between input and output
($V_{iso} : 5\,000V_{rms}$)
2. Low collector dark current
($I_{CEO} : MAX. 6 \times 10^{-9}A$ at $V_{CE} = 5V$)
3. Current transfer ratio
($CTR : MIN. 10\%$ at $I_F = 1mA$, $V_{CE} = 0.4V$)
4. Compact dual-in-line package
5. Recognized by UL, file No. E64380

■ Applications

1. Computer terminals
2. System appliances, measuring instruments
3. Copiers, automatic vending machines, medical instruments
4. Signal transmission between circuits of different potentials and impedances

■ Outline Dimensions

(Unit : mm)

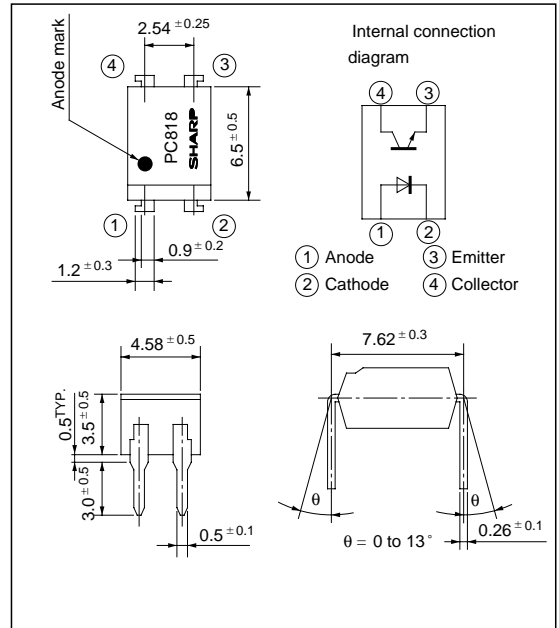

■ Absolute Maximum Ratings

($T_a = 25^\circ C$)

Parameter		Symbol	Rating	Unit
Input	Forward current	I_F	50	mA
	*1 Peak forward current	I_{FM}	1	A
	Reverse voltage	V_R	6	V
	Power dissipation	P	70	mW
Output	Collector-emitter voltage	V_{CEO}	35	V
	Emitter-collector voltage	V_{ECO}	6	V
	Collector current	I_C	50	mA
	Collector power dissipation	P_C	150	mW
Total power dissipation		P_{tot}	200	mW
*2 Isolation voltage		V_{iso}	5 000	V_{rms}
Operating temperature		T_{opr}	- 30 to + 100	$^\circ C$
Storage temperature		T_{stg}	- 55 to + 125	$^\circ C$
*3 Soldering temperature		T_{sol}	260	$^\circ C$

*1 Pulse width $\leq 100\mu s$, Duty ratio : 0.001

*2 40 to 60% RH, AC for 1 minute

*3 For 10 seconds

■ Electro-optical Characteristics

($T_a = 25^\circ\text{C}$)

Parameter		Symbol	Conditions	MIN.	TYP.	MAX.	Unit	
Input	Forward voltage	V_F	$I_F = 20\text{mA}$	-	1.2	1.4	V	
	Peak forward voltage	V_{FM}	$I_{FM} = 0.5\text{A}$	-	-	3.0	V	
	Reverse current	I_R	$V_R = 4\text{V}$	-	-	10	μA	
	Terminal capacitance	C_t	$V = 0, f = 1\text{kHz}$	-	30	250	pF	
Output	Collector dark current	I_{CEO}	$V_{CE} = 5\text{V}, I_F = 0$	-	-	6×10^{-9}	A	
	Current transfer ratio	CTR	$I_F = 1\text{mA}, V_{CE} = 0.4\text{V}$	10	30	100	%	
Transfer characteristics	Collector-emitter saturation voltage	$V_{CE(sat)}$	$I_F = 20\text{mA}, I_C = 1\text{mA}$	-	0.2	0.4	V	
	Isolation resistance	R_{ISO}	DC500V, 40 to 60% RH	5×10^{10}	10^{11}	-	Ω	
	Floating capacitance	C_f	$V = 0, f = 1\text{MHz}$	-	0.6	1.0	pF	
	Turn-off time	t_{off}	$V_{CC} = 5\text{V}, I_F = 1\text{mA}, R_L = 110\text{k}\Omega$	-	-	650	μs	
	Response time	Rise time	t_r	$V_{CE} = 2\text{V}, I_C = 2\text{mA}, R_L = 1\text{k}\Omega$	-	7	40	μs
		Fall time	t_f		-	6	40	μs

Fig. 1 Forward Current vs. Ambient Temperature

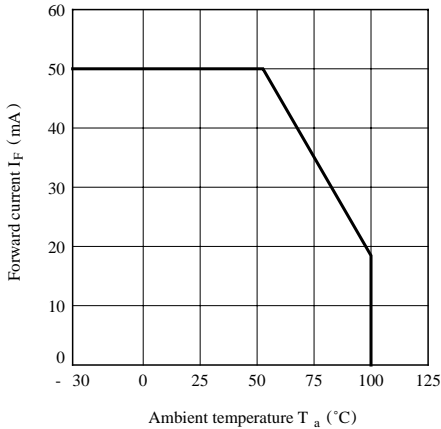

Fig. 2 Collector Power Dissipation vs. Ambient Temperature

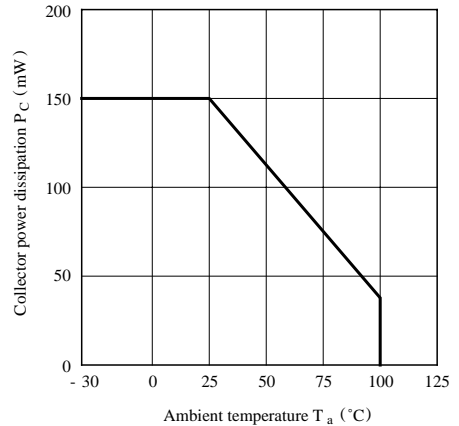

Fig. 3 Peak Forward Current vs. Duty Ratio

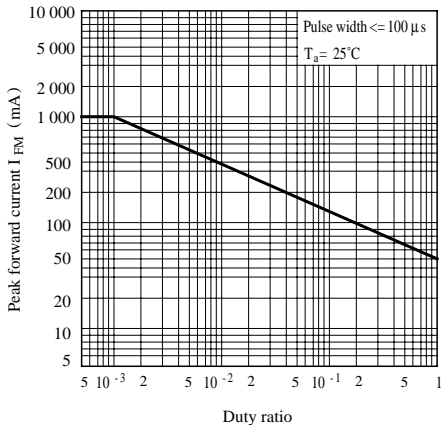

Fig. 4 Forward Current vs. Forward Voltage

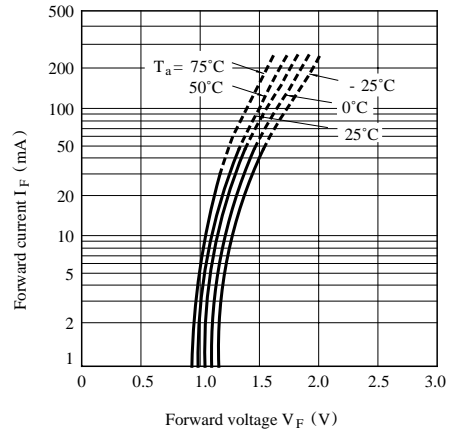

Fig. 5 Current Transfer Ratio vs. Forward Current

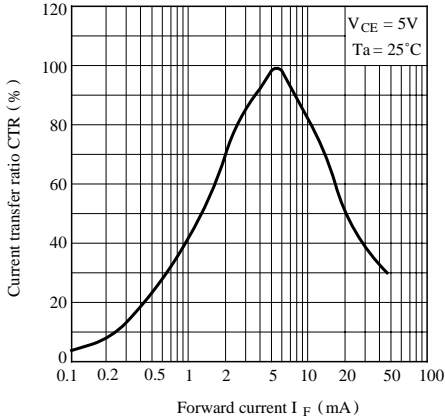

Fig. 6 Collector Current vs. Collector-emitter Voltage

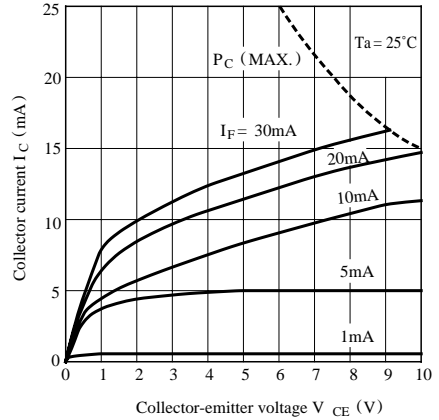

Fig. 7 Relative Current Transfer Ratio vs. Ambient Temperature

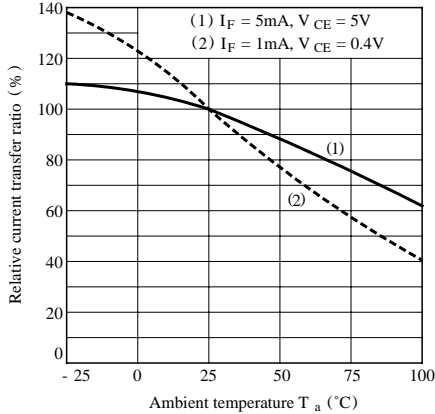

Fig. 8 Collector-emitter Saturation Voltage vs. Ambient Temperature

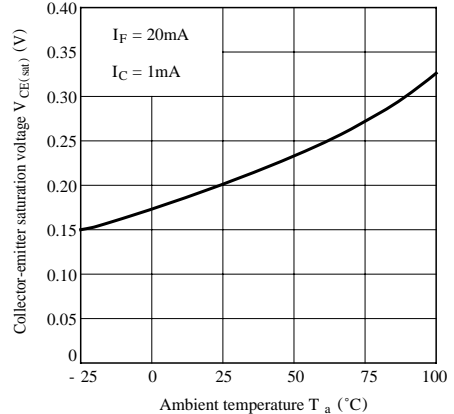

Fig. 9 Collector Dark Current vs. Ambient Temperature

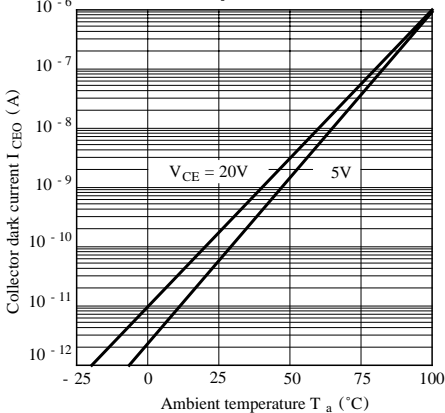

Fig.10 Response Time vs. Load Resistance

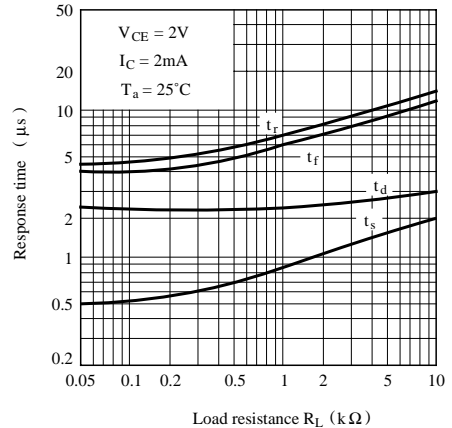
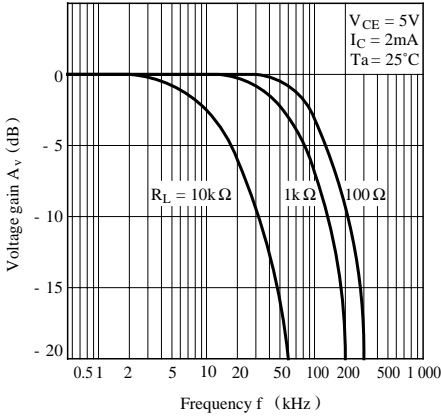

Fig.11 Frequency Response



Test Circuit for Response Time

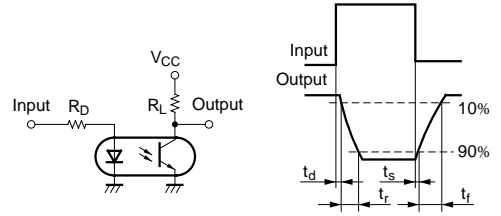
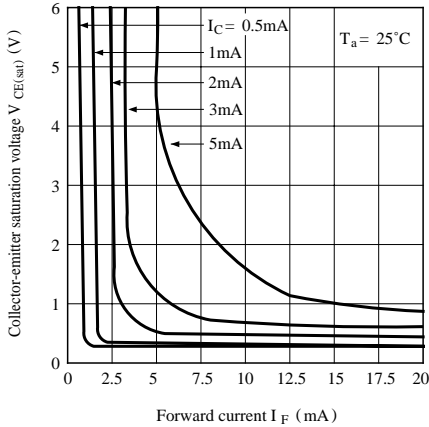
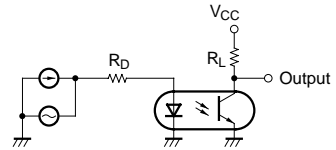

Fig.12 Collector-emitter Saturation Voltage vs. Forward Current



Test Circuit for Frequency Response



● Please refer to the chapter “Precautions for Use”